

# LMD-2110W

Professional LCD Monitor

**SONY**  
make.believe

The LMD-2110W is a 21.5-inch\* full HD-resolution (1920 x 1080 pixels) multi-format professional LCD monitor. A cost-effective entry-level professional monitor, it incorporates high-purity colour filters and a 10-bit digital signal processing engine to deliver stunning colour reproduction and natural grey scale.

In addition to conventional analogue SD input interfaces, the LMD-2110W is equipped with an HDMI interface as standard, and is ideal for a wide range of professional high-definition applications, such as entry-level nonlinear editing, studio source monitoring, surveillance, and various other simple picture monitoring tasks.

\* 547-mm viewing area, measured diagonally.



## // High Picture Performance

### Full HD-resolution (1920 x 1080) LCD panel

The 21.5-inch full HD-resolution LCD panel reproduces lifelike images.

### High-purity Colour Filters

The LMD-2110W monitor provides high-brightness, high-contrast images thanks to its wide aperture LCD panel. In addition, the use of precisely manufactured RGB colour filters allows this monitor to reproduce colours with stunning depth and saturation – creating highly natural images.

### 109% Peak White and 10-bit Signal Processing

Incorporating high-purity RGB colour filters and a 10-bit signal processing engine, the LMD-2110W monitor offers stunning 109% peak white reproduction without clipping and a smooth grey scale along CRT-like gamma.

### Minimized Picture Delay

Picture delay can be minimized for audio synchronization. Selecting LINE DOUBLER in I/P mode, the signal processing (I/P conversion) period is less than one field (0.5 frames).

## // Input Versatility

The LMD-2110W is equipped with a full range of analogue SD inputs including analogue composite NTSC/PAL, Y/C (S-Video), 525i/625i component, and RGB. This monitor can also handle SD-SDI input using an optional BKM-320D SD-SDI input adaptor. Furthermore, it offers an HD signal input capability via the HDMI and analogue component interface.



High-purity colour image



Grey-scale image

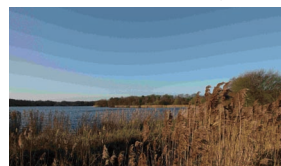
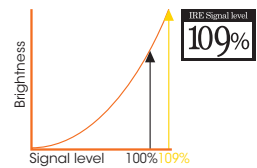

8-bit (256-level) image

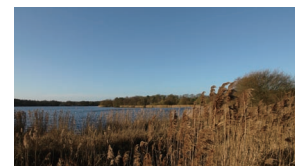

10-bit (1024-level) image

## // Operational Convenience

- Marker function (Center, 16:9, 4:3)
- Scan setting (Normal (0%), Over (5%), Full scan)
- Colour temperature and gamma mode selection
- Aspect setting
- External parallel remote control

## // Mounting Flexibility

- VESA mounting (100 x 100 mm)
- EIA-standard 19-inch rack mountable with an optional MB-529 rack-mount bracket

## Specifications

| LMD-2110W                                 |  |
|---|--|
| <b>Picture Performance</b>                |  |
| Type                                      | a-Si TFT Active Matrix LCD   |
| Resolution                                | 1920 x 1080 pixels   |
| Effective picture size (H x W) (diagonal) | 477 x 268 mm (18 7/8 x 10 5/8 inches), 547 mm (21 5/8 inches)  |
| Aspect                                    | 16:9   |
| Colours                                   | Approx. 16.7 million colours   |
| Viewing angle                             | 170°/160° (typical) (horizontal/vertical contrast>10:1)  |
| <b>Input</b>                              |  |
| Composite                                 | BNC (x1), 1.0 Vp-p ±3dB sync negative  |
| Y/C                                       | Mini DIN 4-pin (x1)<br>Y: 1.0 Vp-p ±3dB sync negative,<br>C: 0.286 Vp-p ±3dB (NTSC burst signal level),<br>0.3 Vp-p ±3dB (PAL burst signal level)    |
| RGB, Component                            | BNC (x3)<br>RGB : 0.7 Vp-p ±3dB (sync on green, 0.3 Vp-p sync negative)<br>Component : 0.7 Vp-p ±3dB<br>(75% chrominance standard colour bar signal) |
| HDMI                                      | HDMI (x1)  |
| Audio                                     | Phono jack (x2), -5 dBu 47 kilohms or higher<br>OPTION AUDIO IN: Phono jack (x1), -5 dBu 47 kilohms or higher  |
| External sync                             | BNC (x1), 0.3 Vp-p to 4 Vp-p negative polarity binary  |
| Option in connector                       | D-sub 9-pin (x1), female   |
| Parallel remote                           | Modular connector 8-pin (x1) (pin-assignable)  |
| <b>Output</b>                             |  |
| Composite                                 | BNC (x1), loop-through, with 75 ohms automatic termination   |
| Y/C                                       | Mini DIN 4-pin (x1) loop-through, with 75 ohms automatic termination   |
| RGB, Component                            | BNC (x3), loop-through, with 75 ohms automatic termination   |
| External sync                             | BNC (x1), loop-through, with 75 ohms automatic termination   |
| Audio monitor out                         | Phono jack (x2), loop-through  |
| Speaker (built-in)                        | 0.5 W (mono)   |
| <b>General</b>                            |  |
| Power requirements                        | AC 100 V to 240 V, 50/60 Hz  |
| Power consumption                         | Maximum approx. 56 W, 1.0 A to 0.5 A   |
| Operating temperature                     | 0°C to 35°C (32°F to 95°F)<br>Recommended: 20°C to 30°C (68°F to 86°F)   |
| Operating humidity                        | 30% to 85% (no condensation)   |
| Storage and transport temperature         | -20°C to +60°C (-4°F to +140°F)  |
| Storage and transport humidity            | 0% to 90%  |
| Operating, storage and transport pressure | 700 hPa to 1060 hPa  |
| Dimensions (W x H x D) (with stand)       | 515 x 403 x 264 mm (20 3/8 x 15 7/8 x 10 1/2 inches)   |
| Dimensions (W x H x D) (without stand)    | 515 x 355 x 86 mm (20 3/8 x 14 x 3 1/2 inches)   |
| Mass                                      | 8.6 kg (18 lb 15 oz)   |
| Mass (without stand)                      | 6.9 kg (14 lb 19 oz)   |
| Accessories supplied                      | AC power cord (1), AC plug holder (1), Operating Instructions (1),<br>CD-ROM (1), Using the CD-ROM Manual (1), Warranty book (1)                     |

## Optional Accessories

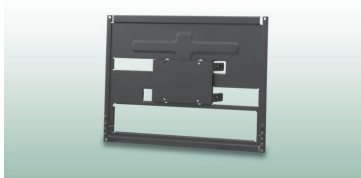

**MB-529**  
Mounting Bracket



**BKM-320D**  
SD-SDI Input Adaptor

## Dimensions

Unit: mm (inches)

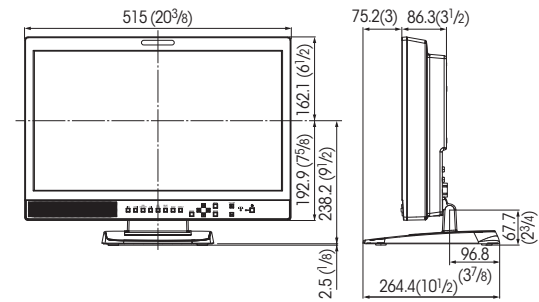

## Front Panel

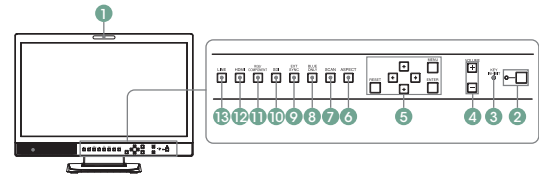

- 1 Tally lamp
- 2 standby switch and indicator
- 3 KEY INHIBIT indicator
- 4 VOLUME buttons
- 5 Menu operation buttons
- 6 ASPECT select button
- 7 SCAN select button
- 8 BLUE ONLY button
- 9 EXT SYNC (external sync) button
- 10 SDI button
- 11 RGB/COMPONENT button
- 12 HDMI button
- 13 LINE

## Connector Panel

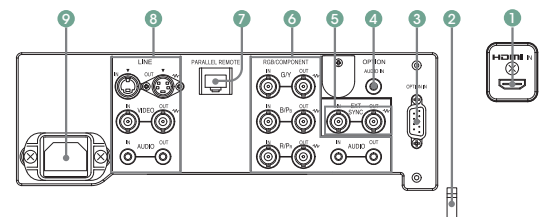

- 1 HDMI IN connector
- 2 HDMI cable holder
- 3 OPTION In connector
- 4 OPTION AUDIO In (Phono jack)
- 5 EXT SYNC In/Out (external sync) (BNC)
- 6 RGB/COMPONENT (BNC), Audio (Phono jack)
- 7 PARALLEL REMOTE (modular connector)
- 8 LINE [composite (BNC), Y/C (Mini DIN 4-pin),  
Audio (Phono jack)]
- 9 AC In



### Distributed by

©2010 Sony Corporation. All rights reserved.  
Reproduction in whole or in part without written permission is prohibited.  
Features and specifications are subject to change without notice.

Images on monitors are simulated.

The values for mass and dimension are approximate.  
"SONY" and "make.believe" are trademarks of Sony Corporation.  
All other trademarks are the properties of their respective owners.